

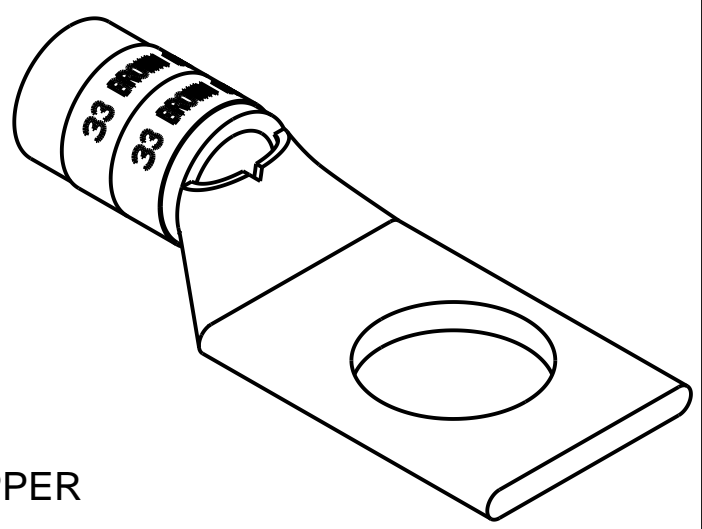

Blackburn Compression

Featuring the Color-Keyed® System

CATALOG NO. 54145-TB

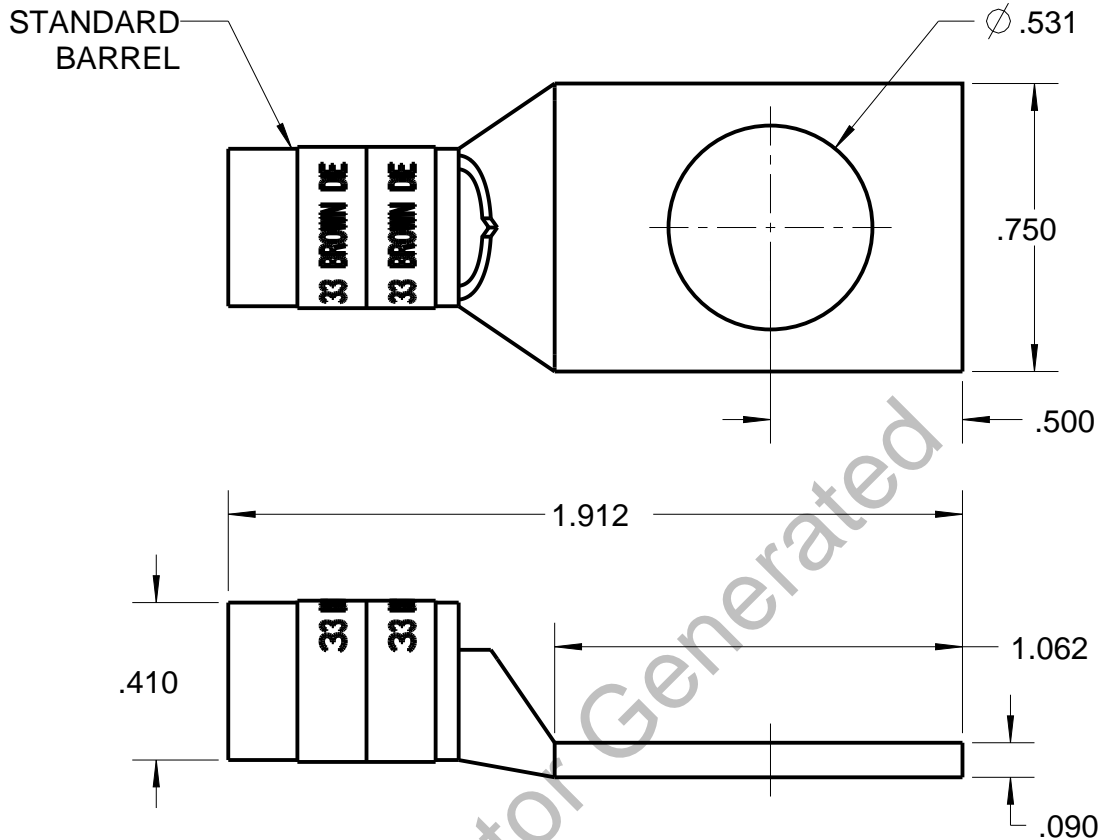

WIRE SIZE: # 2 AWG
 MATERIAL: HIGH CONDUCTIVITY COPPER
 FINISH: TIN PLATED

GENERAL NOTES		 www.tnb.com			
1. ALL DIMENSIONS ARE FOR REFERENCE ONLY. 2. DIMENSIONS IN BRACKETS [] ARE IN METRIC UNITS.					
REVISIONS		DESCRIPTION: 1 HOLE LUG			
** SEE ERN (****) FOR APPROVAL SIGNATURES & RELEASE DATE. PROJECT NO: ****		ORIGINAL PROJECT NO / (ERN NO)	SHEET NO:	REV. NO:	DRAWING NO: WSD-002009
		/ ()	1 OF 1	0	54145-TB